

POWER-RGB 22W

User Manual

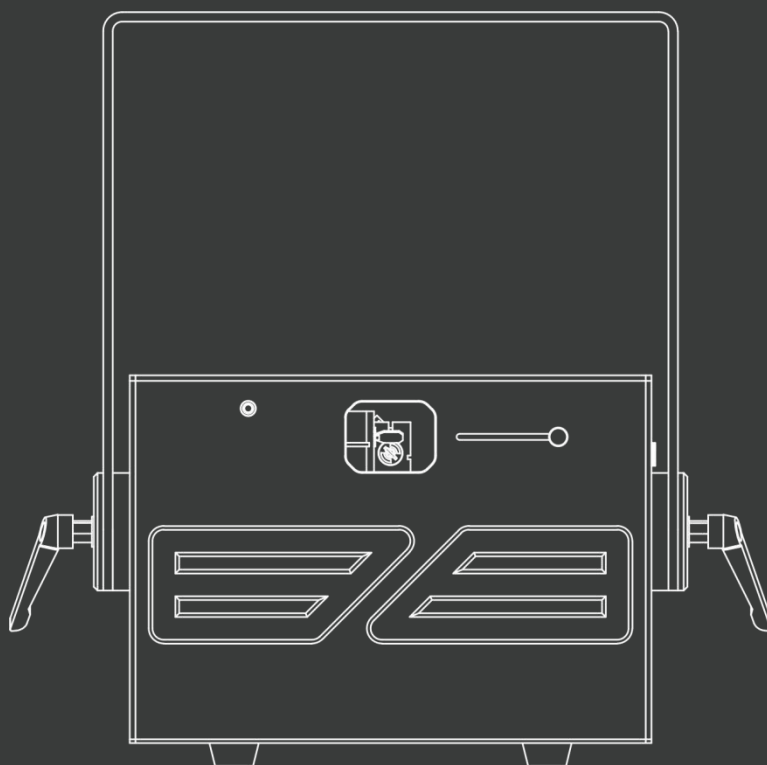

INTRODUCTION

Thank you for purchasing our product.

To ensure proper operation, please read this manual carefully before using the product. It could help you avoid dangerous and hazardous situations which could lead to serious injury or property damage.

The manufacturer and its distributors cannot be held responsible for any damages caused by improper use or misuse of this laser system.

The owner/user is fully responsible for using this product in accordance to laser safety regulations of the country or state where the system is being used.

Keep this User Manual for future consultation. If you sell this product to another user, be sure that they also receive this document.

1. ACCESSORIES

- 1 X Laser projector
- 1 X Flight case/ Plastic hard case (selectable)
- 1X Safety key for projector
- 1 X E-stop RJ45 plug (Shunt)
- 1X Power cord
- 1X Metal safety wire

2. UNPACKING INSTRUCTIONS

Open the flight case/ carton box carefully unpack everything inside. Ensure all parts are present and in good condition.

Do not use any equipment that appears to be damaged.

3. DIMENSIONS

All dimensions are given in millimeters

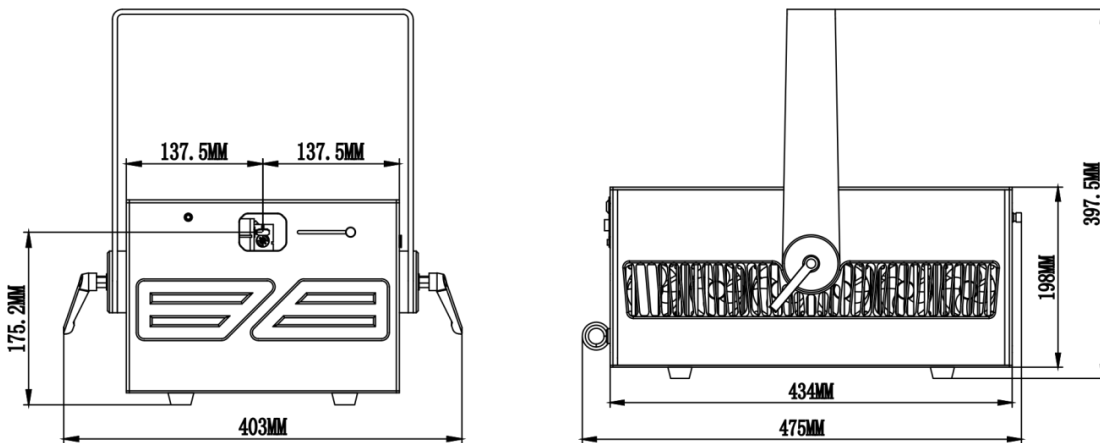

Hazard Warning Symbol



Explanatory Label

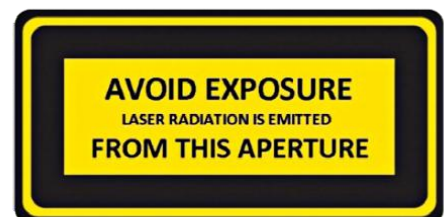

Aperture Label

4. SAFETY NOTES

WARNING! This projector is a Class 4 laser product. It must never be used for audience-scanning applications. The output beam of the projector must always be at least 3 meters above the floor in the audience. See the Proper Operation section for further information.

Please read the following notes carefully! They include important safety information about the installation, usage, and maintenance of this product.

- Keep this User Manual for future consultation. If you sell this product to another user, be sure that they also receive this document.
- Always make sure that the voltage of the outlet to which you are connecting this product is within the range stated on the decal or rear panel of the product.
- Product is not designed for use outdoors in adverse weather conditions. To prevent risk of fire or shock, do not expose this product to rain or moisture.
- Always install this product in a location with adequate ventilation, at least 20 in (50 cm) from adjacent surfaces. Be sure that no ventilation slots are blocked.
- Always disconnect this product from the power source before cleaning it or replacing the fuse.
- Make sure to replace the fuse with another of the same type and rating.
- If mounting it overhead, always secure this product to a fastening device using a safety chain or cable.
- In the event of a serious operating problem, stop using the projector immediately. Never try to repair the unit except in a controlled environment under trained supervision. Repairs carried out by unskilled people can lead to damage or malfunction of the unit, as well as exposure to dangerous laser light.
- Never connect this product to a dimmer pack.
- Make sure the power cord is not crimped or damaged.
- Never disconnect the power cord by pulling on any moving part. Always use the hanging/mounting bracket or the handles. Or tugging on the cord.
- Never carry a product from the power cord.
- Always avoid eye or skin exposure to direct or scattered light from this product.
- Lasers can be hazardous and have unique safety considerations. Permanent eye injury and blindness is possible if lasers are used incorrectly. Pay close attention to each safety REMARK and WARNING statement in this user manual. Read all instructions carefully BEFORE operating this device.
- It is illegal and dangerous to shine this laser into audience areas, where the audience or other personnel could get direct laser beams or bright reflections into their eyes.
- It is a US Federal offense to shine any laser at aircraft.
- There are no user serviceable parts inside the unit. Do not open the housing or attempt any repairs yourself. Service is only to be handled by the factory or authorized factory trained technicians.
- Product is not to be modified by the customer.
- **Caution** use of controls or adjustments or performance of procedures other than those specified herein may result in hazardous radiation exposure.

5. TECHNICAL SPECIFICATIONS

Laser:

Laser Classification: Class 4

Laser sources: Full diode lasers

Beam diameter (1/e²): <5.0mm

Beam divergence (1/e²): <1.0mrad (full angle)

Laser Wave Length: 445-640nm

Maximum total output power: 22,000mW

Projector:

Scanner: 35kpps@8°

Aperture: 6mm

Scan angle: 50degree, Max: 60degree

Laser emission window: B+W antireflective coated

AC power input: 100-240VAC / 50-60Hz

Input power: 900W maximum

Max. ambient temperature: 40°C

Min. ambient temperature: -5°C

Weight: 24kg

6. THE SPECIFICATION OF THE FRONT AND REAR PANEL

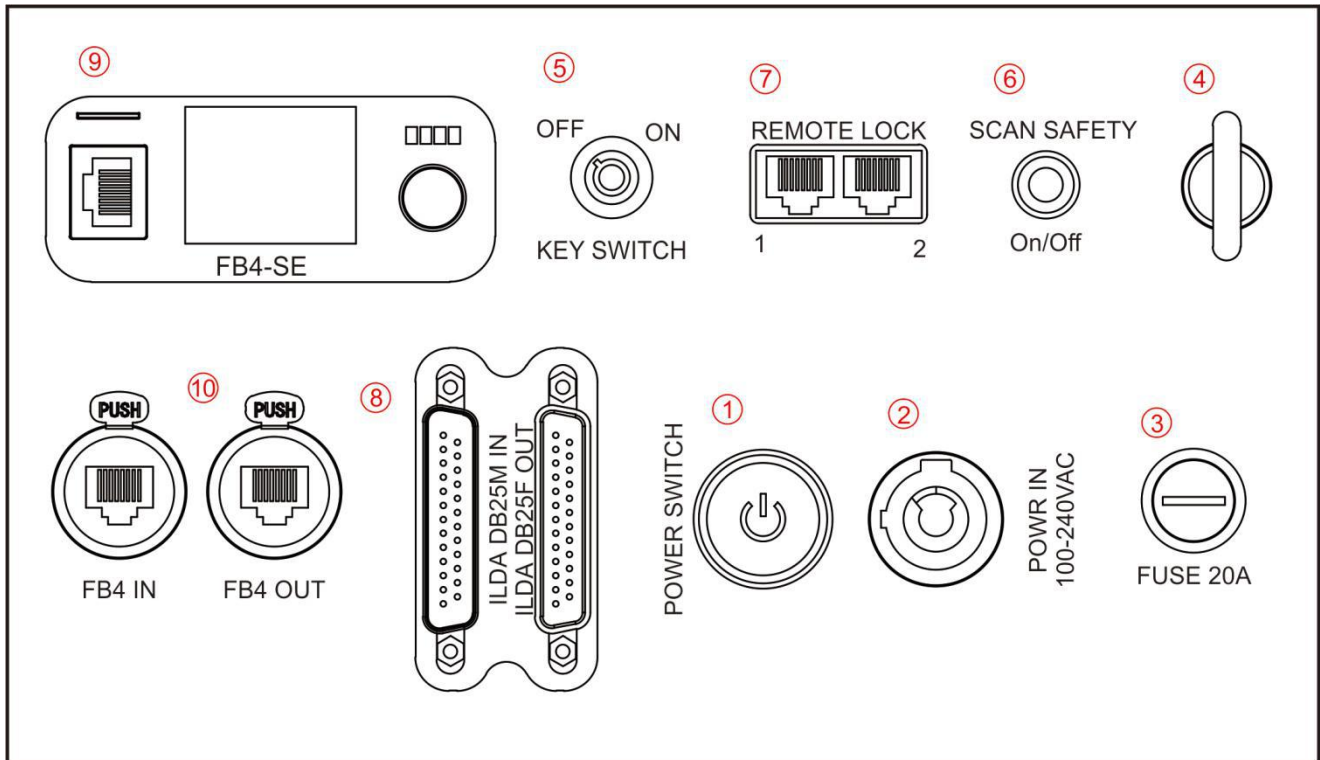

1. ON/OFF, POWER SWITCH
2. POWER IN/OUT
3. MAIN FUSE HOLDER
4. SAFETY HOOK
5. KEY SWITCH
6. SCAN-FAIL SAFETY SWITCH
7. REMOTE LOCK (INTERLOCK)
8. ILDA IN/ILDA OUT
9. PANGOLIN FB4
10. RJ45 (FB4 IN & OUT)

7. REMOTE INTERLOCK / REMOTE E-STOP BOX

- 1) If you do not use E-stop box, please insert the white RJ45 plug (shunt) to the projector.(Refer photo below)
- 2) Connect the remote E-stop box to any of the RJ45 connector (Remote lock) on the rear of the projector using Ethernet cable. Ensure that the other end of the cable is firmly attached to the E-stop box.

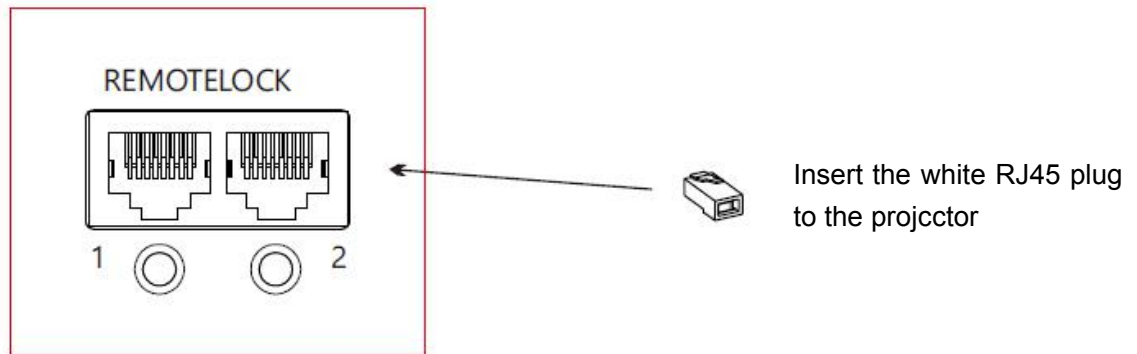

8. RIGGING

- 1) Be sure that the structure onto which you are mounting this product can support its weight.
- 2) Mount the product securely. You can do this with a screw, a nut, and a bolt. You may also use a mounting clamp if rigging this product onto a truss. The U-shaped support bracket has three mounting holes which may be used to secure the clamps to the projector.
- 3) When mounting this product overhead, always use a safety cable.
- 4) Always consider ease of access to the unit before deciding on a location for this product.

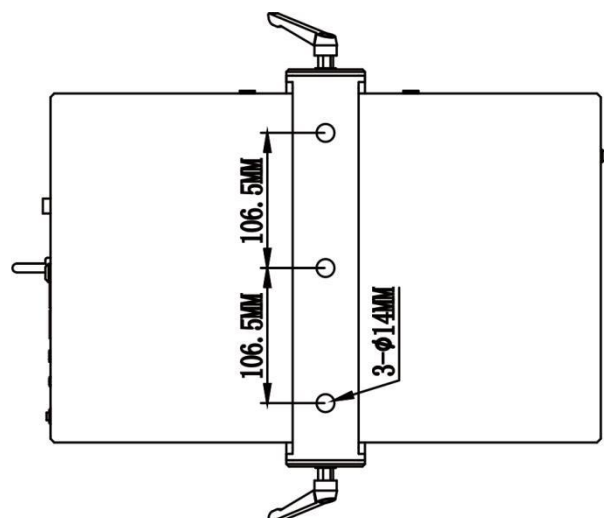

9. OPERATION OF 360 DEGREE BRACKET

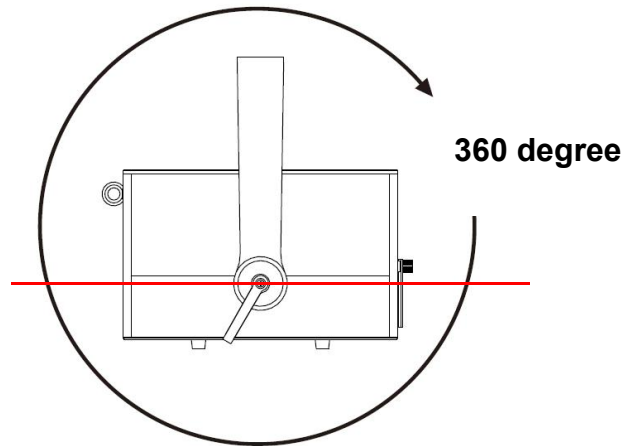

10. EASY BEAM ALIGNMENT MECHANISM

- 1) Screw bolt 1, to access the color alignment of red laser.
- 2) Screw bolt 2, to access the color alignment of green laser.

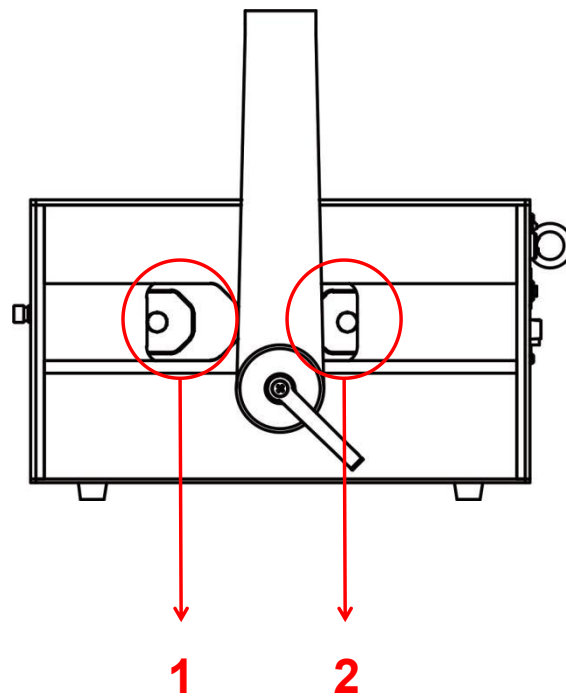

11. PROPER USE

This product is for overhead mounting only. For safety purposes, this projector should be mounted on steady elevated platforms or sturdy overhead supports using suitable hanging clamps. In all cases, you must use safety cables.

International laser safety regulations require that laser products must be operated in the fashion illustrated below, with a minimum of 3 meters (9.8 ft) of vertical separation between the floor and the lowest laser light vertically. Additionally, 3 meters of horizontal separation is required between laser light and audience or other public spaces.

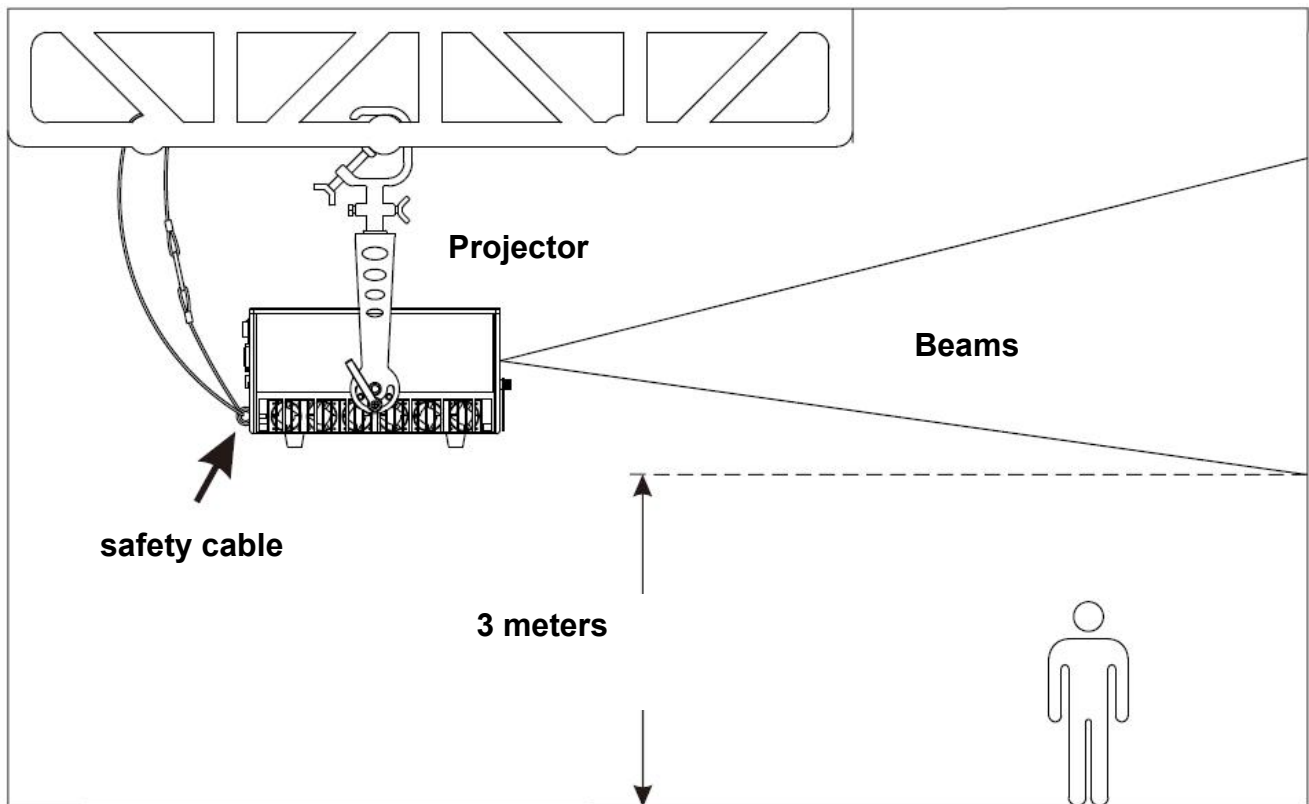

Caution – use of controls or adjustments or performance of procedures other than those specified herein may result in hazardous radiation exposure.

12. WIRING DIAGRAM

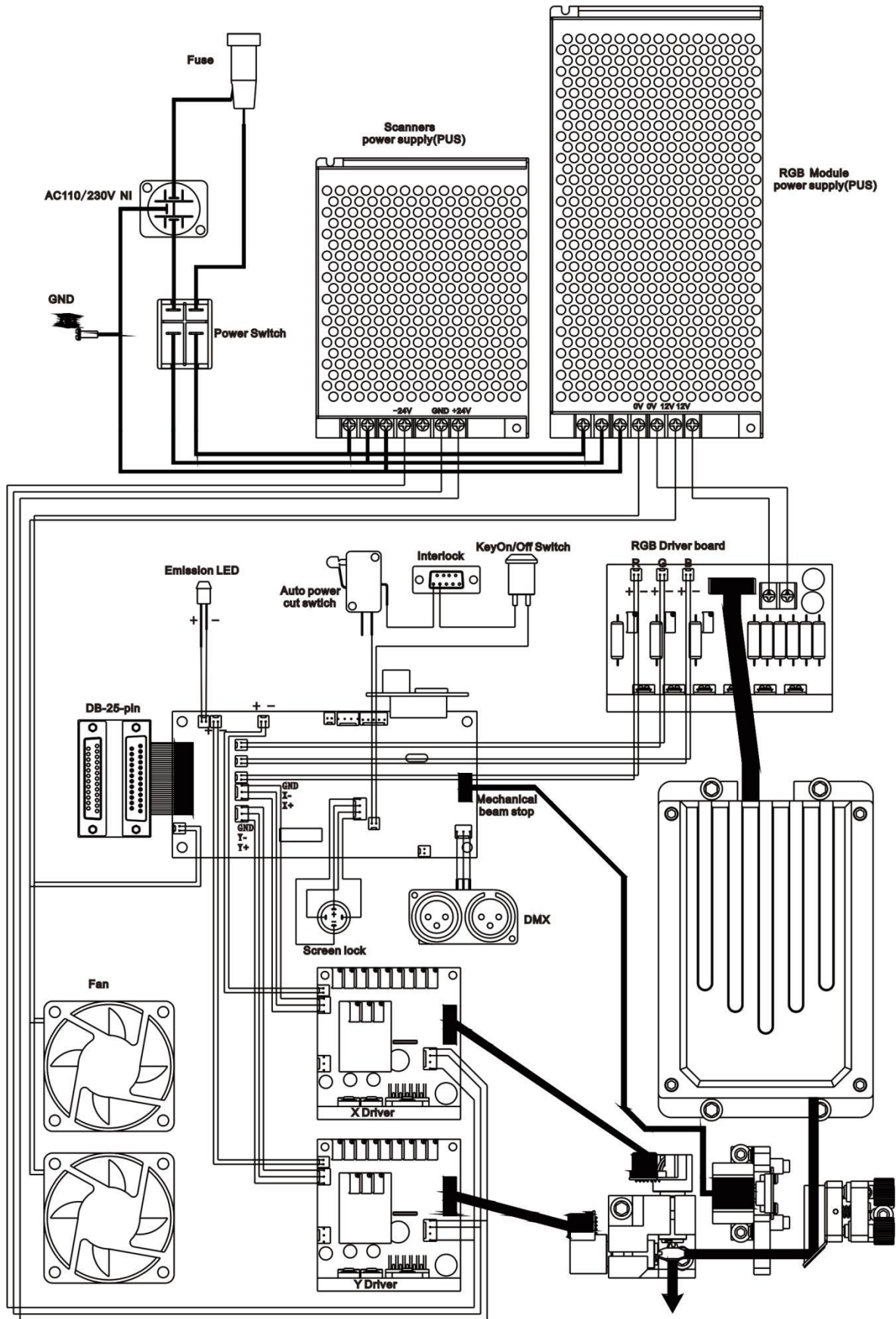

13. ILDA CONNECTION

Connect the projector to your controller using a standard 25-pin ILDA cable (DB-25). Be sure to tighten the connecting screws to ensure the cable does not become disconnected.

This projector is wired to accept ILDA standard analog signals for X, Y and color information. The ILDA standard uses a DB-25 cable to carry these signals from the controller to the projector.

Above-DB25 male connector,viewed from front.

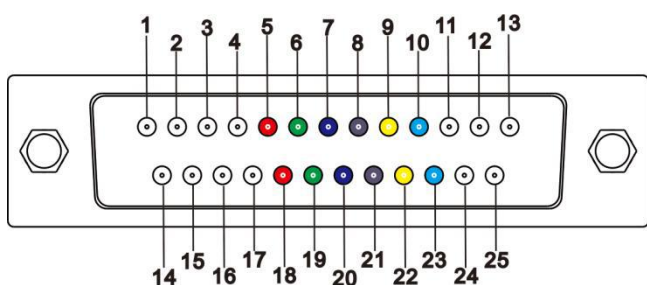

Below-DB25 female connector,viewed from front.

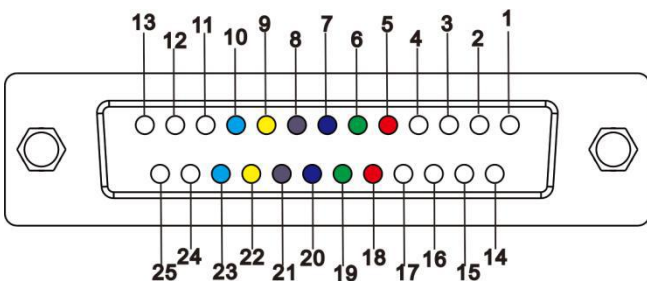

ILDA PINOUT

Pin:		Pin:	
1	X+	14	X-
2	Y+	15	Y-
3	Intensity/Blanking+	16	Intensity/Blanking-
4	Interlock A	17	Interlock B
5	Red+	18	Red-
6	Green+	19	Green-
7	Blue+	20	Blue-
8	Deep blue+	21	Deep blue-
9	Yellow+	22	Yellow-
10	Cyan+	23	Cyan-
11	Z+	24	Z-
12	Not connected	25	Ground
13	Shutter		

THE PROJECTORS ONLY USE THE FOLLOWING PINS:

PIN:		PIN:	
1	X+	14	X-
2	Y+	15	Y-
3	Intensity/Blanking+	16	Intensity/Blanking-
4	Interlock A	17	Interlock B
5	Red+	18	Red-
6	Green+	19	Green-
7	Blue+	20	Blue-
13	Shutter	25	Ground



联系电话：020-89680163